

Model TS318-1B0814 Thermopile Sensor



- Thermopile IR-Sensor
- For Contactless Temperature Measurement
- Single Element
- Small Package for Ear Thermometer
- High Signal
- Flat Filter
- Accurate Reference Sensor

DESCRIPTION

Thermopiles are mainly used for contactless temperature measurement in many applications. Their function is to transfer the heat radiation emitted from the objects into a voltage output.

FEATURES

- High Signal
- Ni-RTD Reference Sensor
- Small TO-18 Package
- 8-14 μ m Band Pass Filter for measurement distances >0.5m

APPLICATIONS

- Pyrometers (general)
- Industrial Pyrometers

ABSOLUTE MAXIMUM RATINGS

Parameter	Symbol	Min	Typical	Max	Unit	Description
Storage Temperature	T _s	-20	+20	+85	°C	permanent
Storage Temperature	T _s	-20	+20	+100	°C	non permanent

Model TS318-1B0814 Thermopile Sensor

PERFORMANCE SPECS

Parameter	Symbol	Value	Unit	Condition
Operating Ambient Temperature	T_{Amb}	-20 to +85	°C	permanent
Operating Ambient Temperature	T_{Amb}	-20 to +100	°C	non permanent
Package		TO-18		
Absorber Area	A	0.8×0.8	mm ²	
Thermopile Resistance	R_{TP}	70 ± 30	k Ω	$T_{Amb} = +25\text{ }^{\circ}\text{C}$
Temperature Coefficient of Thermopile Resistance	TCR_{TP}	-0.06 ± 0.04	%/K	$T_{Amb} = +25\text{ }^{\circ}\text{C}$ to $+75\text{ }^{\circ}\text{C}$
Voltage Response	V_{TP}	5.0 ± 1.3	mV	$T_{Amb} = +25\text{ }^{\circ}\text{C}$, $T_{Obj} = +100\text{ }^{\circ}\text{C}$, DC, totally filled field of view
Temperature Coefficient of Voltage Response	TCV_{TP}	-0.45 ± 0.08	%/K	$T_{Amb} = +25\text{ }^{\circ}\text{C}$ to $+75\text{ }^{\circ}\text{C}$
Noise Equivalent Voltage	NEV	34	nV/Hz ^{1/2}	$T_{Amb} = +25\text{ }^{\circ}\text{C}$
Rise Time	τ_{63}	12 ± 5	ms	
Ambient Temperature Sensor		Ni-RTD		
Ambient Temperature Sensor Resistance	R_{Ni-RTD}	1000 ± 4	Ω	$T_{Amb} = 0\text{ }^{\circ}\text{C}$
Temperature Coefficient of Ni-RTD	TC_{Ni-RTD}	6178 ± 150	ppm/K	$T_{Amb} = 0\text{ }^{\circ}\text{C}$ to $+100\text{ }^{\circ}\text{C}$

TYPICAL PERFORMANCE CURVES

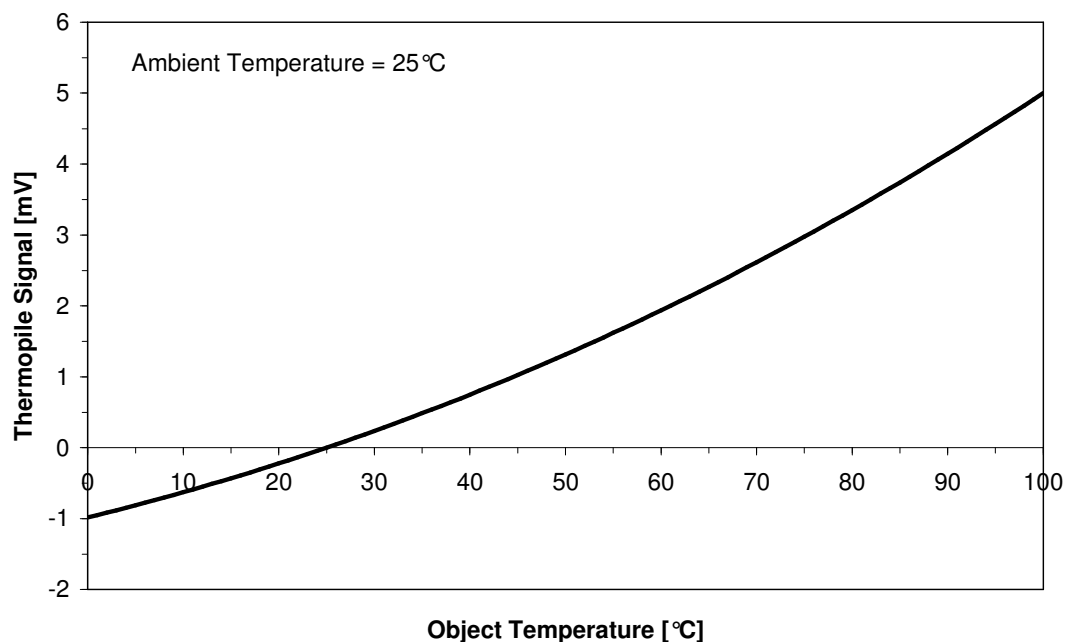

Figure 1: Thermopile signal versus object temperature at 25°C ambient temperature

Model TS318-1B0814 Thermopile Sensor

OPTICAL CHARACTERISTICS

Parameter	Symbol	Value	Unit	Description
Field of View	FOV	110	deg	at 50% of maximum signal

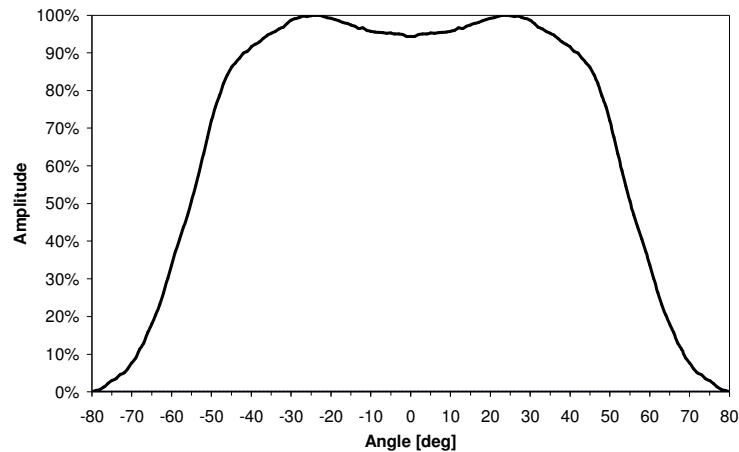

Figure 2: Field of View Curve

FILTER CHARACTERISTICS

Parameter	Symbol	Value	Unit	Description
Transmission Range	BBP	8-14	μm	Broad Band Pass
Transmission	$T_{9 \dots 13\mu\text{m}}$	≥ 75.0	%	at 9 ... 13 μm

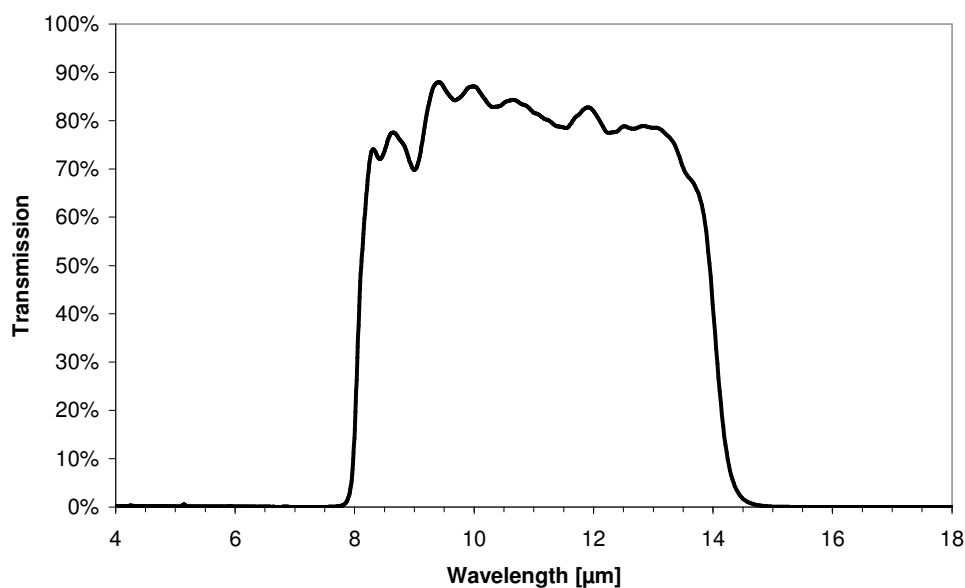

Figure 3: Filter transmission curve

Model TS318-1B0814 Thermopile Sensor

ELECTRICAL CONNECTIONS

Pin	Symbol
1	TP +
2	Ni-RTD
3	TP -
4	GND

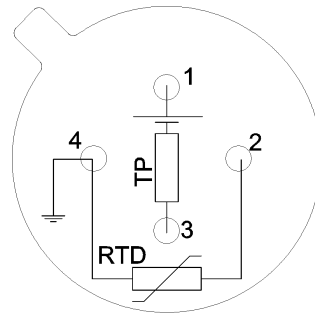
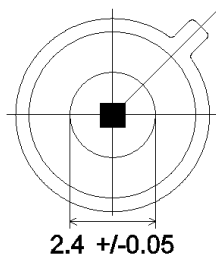

Figure 4: Electrical connections - bottom view of thermopile

MECHANICAL DIMENSIONS

TOP VIEW



SIDE VIEW

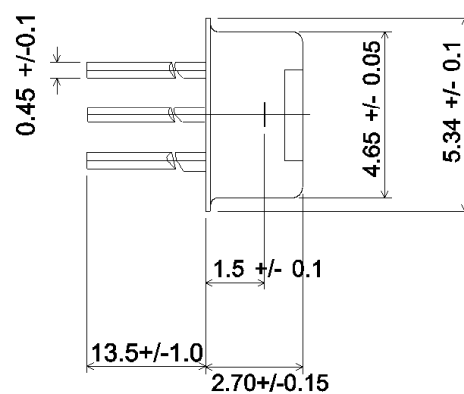

BOTTOM VIEW

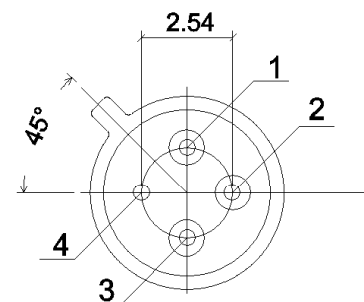

Figure 5: Mechanical dimensions of thermopile

Model TS318-1B0814 Thermopile Sensor

ORDERING INFORMATION

Part Descripton TS318-1B0814

Part No. G-TPCO-031