



## MS5837-30BA

### Ultra Small Gel Filled Pressure Sensor

#### SPECIFICATIONS

- Ceramic - metal package, 3.3 x 3.3 x 2.75mm
- High-resolution module 0.2 mbar
- Fast conversion down to 0.5 ms
- Low power, 0.6  $\mu$ A (standby < 0.1  $\mu$ A at 25°C)
- Integrated digital pressure sensor (24 bit  $\Delta\Sigma$  ADC)
- Supply voltage 1.5 to 3.6 V
- Operating range: 0 to 30 bar, -20 to +85 °C
- I<sup>2</sup>C interface
- No external components (Internal oscillator)
- Excellent long term stability
- Hermetically sealable for outdoor devices
- Sealing designed for 1.8 x 0.8mm O-ring

The MS5837-30BA is a new generation of high resolution pressure sensors with I<sup>2</sup>C bus interface for depth measurement systems with a water depth resolution of 2 mm. The sensor module includes a high linearity pressure sensor and an ultra-low power 24 bit  $\Delta\Sigma$  ADC with internal factory calibrated coefficients. It provides a precise digital 24 Bit pressure and temperature value and different operation modes that allow the user to optimize for conversion speed and current consumption. A high resolution temperature output allows the implementation in depth measurement systems and thermometer function without any additional sensor. The MS5837-30BA can be interfaced to virtually any microcontroller. The communication protocol is simple, without the need of programming internal registers in the device. The gel protection and antimagnetic stainless steel cap make the module water resistant. This new sensor module generation is based on leading MEMS technology and latest benefits from MEAS Switzerland proven experience and know-how in high volume manufacturing, which has been widely used for over a decade.

## PERFORMANCE SPECIFICATIONS

## ABSOLUTE MAXIMUM RATINGS

Parameter	Symbol	Conditions	Min.	Typ.	Max	Unit
Supply voltage	$V_{DD}$		-0.3		+4	V
Storage temperature	$T_S$		-40		+85	°C
Overpressure	$P_{max}$	ISO 22810			50	Bar
Maximum Soldering Temperature	$T_{max}$	40 sec max			250	°C
ESD rating		Human Body Model	-2		+2	kV
Latch up		JEDEC standard No 78	-100		+100	mA

## ELECTRICAL CHARACTERISTICS

Parameter	Symbol	Conditions	Min.	Typ.	Max	Unit
Operating Supply voltage	$V_{DD}$		1.5	3.0	3.6	V
Operating Temperature	T		-20	+25	+85	°C
Supply current (1 sample per sec.)	$I_{DD}$	OSR	8192 4096 2048 1024 512 256	20.09 10.05 5.02 2.51 1.26 0.63		$\mu$ A
Peak supply current		during conversion		1.25		mA
Standby supply current		at 25°C		0.01	0.1	$\mu$ A
VDD Capacitor		From VDD to GND	100	470		nF

## ANALOG DIGITAL CONVERTER (ADC)

Parameter	Symbol	Conditions	Min.	Typ.	Max	Unit	
Output Word				24		Bit	
Conversion time <sup>(1)</sup>	$t_c$	OSR	8192 4096 2048 1024 512 256	14.8 7.40 3.72 1.88 0.95 0.48	16.44 8.22 4.13 2.08 1.06 0.54	18.08 9.04 4.54 2.28 1.17 0.60	ms

(1): Maximum values must be applied to determine waiting times in I2C communication

PERFORMANCE SPECIFICATIONS (CONTINUED)

PRESSURE OUTPUT CHARACTERISTICS ( $V_{DD} = 3\text{ V}$ ,  $T = 25^\circ\text{C}$  UNLESS OTHERWISE NOTED)

Parameter	Conditions		Min.	Typ.	Max	Unit
Operating Pressure Range	$P_{\text{range}}$	Full Accuracy	0		30	Bar
Absolute Accuracy (1), Temperature range: 0 ... 40°C	0 ... 6 bar		-50		+50	mbar
	0 ... 20 bar		-100		+100	
	0 ... 30 bar		-200		+200	
Absolute Accuracy (1), Temperature range: -20 ... 85°C	0 ... 6 bar		-100		+100	mbar
	0 ... 20 bar		-200		+200	
	0 ... 30 bar		-400		+400	
Maximum error with supply voltage (2)	$V_{DD} = 1.5\text{ V} \dots 3.6\text{ V}$			$\pm 30$		mbar
Long-term stability				$\pm 30$		mbar/year
Resolution RMS	OSR	8192		0.20	mbar	
		4096		0.28		
		2048		0.38		
		1024		0.54		
		512		0.84		
		256		1.57		
Reflow soldering impact	IPC/JEDEC J-STD-020D.1 (See application note AN808 on <a href="http://meas-spec.com">http://meas-spec.com</a> )			-8		mbar
Recovering time after reflow (3)				7		Days

- (1) With autozero at one pressure point
- (2) With autozero at 3V point
- (3) Time to recover at least 66% of the reflow impact.

TEMPERATURE OUTPUT CHARACTERISTICS ( $V_{DD} = 3\text{ V}$ ,  $T = 25^\circ\text{C}$  UNLESS OTHERWISE NOTED)

Parameter	Conditions		Min.	Typ.	Max	Unit
Absolute Accuracy	0 ... 10 bar, 25°C		-1.5		+1.5	°C
	0 ... 10 bar, 0..60°C		-2.0		+2.0	
	-20..85°C		-4.0		+4.0	
Maximum error with supply voltage	$V_{DD} = 1.5\text{ V} \dots 3.6\text{ V}$			$\pm 0.3$		°C
Resolution RMS	OSR	8192		0.0022	°C	
		4096		0.0026		
		2048		0.0033		
		1024		0.0041		
		512		0.0055		
		256		0.0086		

PERFORMANCE SPECIFICATIONS (CONTINUED)

DIGITAL INPUTS (SCL, SDA)

Parameter	Symbol	Conditions	Min.	Typ.	Max	Unit
Serial data clock	SCL				400	kHz
Input high voltage	V <sub>IH</sub>		80% V <sub>DD</sub>		100% V <sub>DD</sub>	V
Input low voltage	V <sub>IL</sub>		0% V <sub>DD</sub>		20% V <sub>DD</sub>	V
Input leakage current	I <sub>leak25°C</sub>	at 25°C			0.1	μA

DIGITAL OUTPUTS (SDA)

Parameter	Symbol	Conditions	Min.	Typ.	Max	Unit
Output high voltage	V <sub>OH</sub>	I <sub>source</sub> = 0.6 mA	80% V <sub>DD</sub>		100% V <sub>DD</sub>	V
Output low voltage	V <sub>OL</sub>	I <sub>sink</sub> = 0.6 mA	0% V <sub>DD</sub>		20% V <sub>DD</sub>	V

## PERFORMANCE CHARACTERISTICS

### PRESSURE ERROR VS PRESSURE AND TEMPERATURE

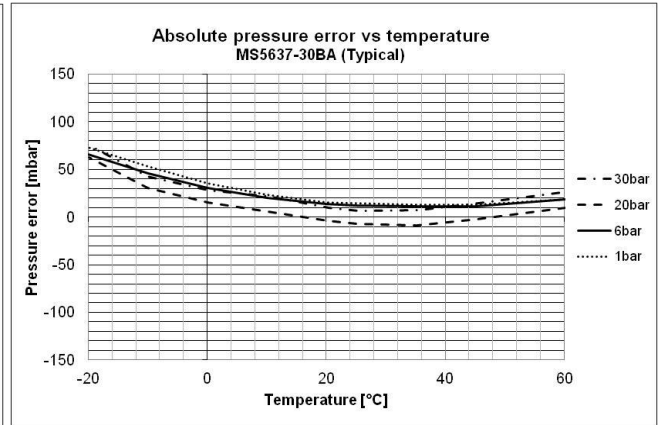
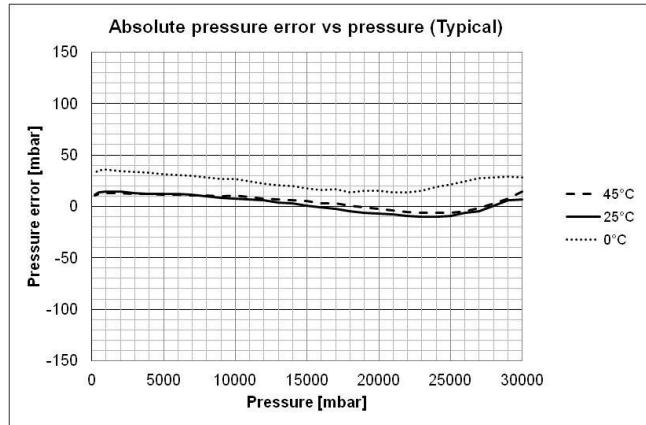

### TEMPERATURE ERROR VS PRESSURE AND TEMPERATURE

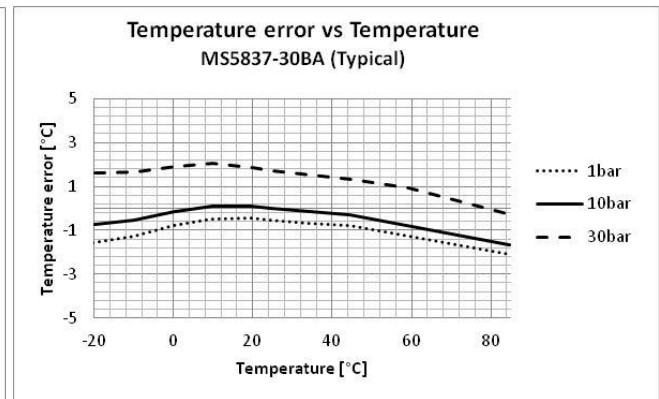
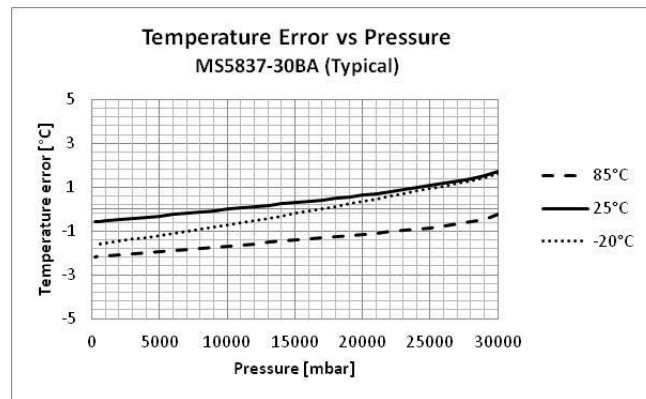

### PRESSURE AND TEMPERATURE ERROR VS POWER SUPPLY

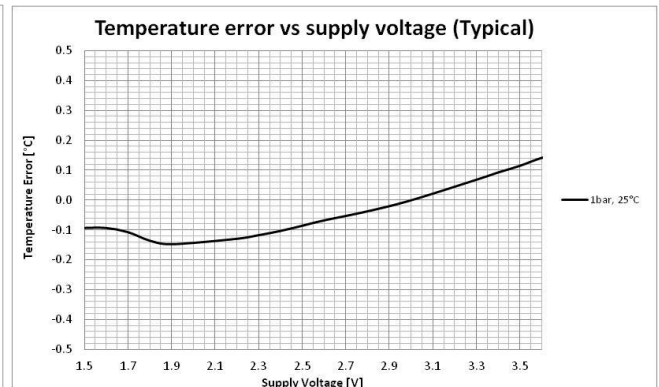
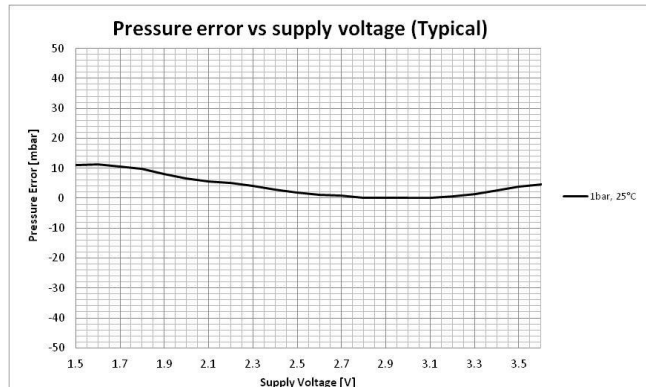

## FUNCTIONAL DESCRIPTION

### GENERAL

The MS5837-30BA consists of a piezo-resistive sensor and a sensor interface IC. The main function of the MS5837-30BA is to convert the uncompensated analogue output voltage from the piezo-resistive pressure sensor to a 24-bit digital value, as well as providing a 24-bit digital value for the temperature of the sensor.

### FACTORY CALIBRATION

Every module is individually factory calibrated at two temperatures and two pressures. As a result, 6 coefficients necessary to compensate for process variations and temperature variations are calculated and stored in the 112-bit PROM of each module. These bits (partitioned into 6 coefficients W1 to W6) must be read by the microcontroller software and used in the program converting D1 and D2 into compensated pressure and temperature values.

The coefficients W0 is for factory configuration and CRC.

### SERIAL I2C INTERFACE

The external microcontroller clocks in the data through the input SCL (Serial CLock) and SDA (Serial DAta). The sensor responds on the same pin SDA which is bidirectional for the I<sup>2</sup>C bus interface. So this interface type uses only 2 signal lines and does not require a chip select.

Module ref	Mode	Pins used
MS5837-30BA	I <sup>2</sup> C	SDA, SCL

**PRESSURE AND TEMPERATURE CALCULATION**

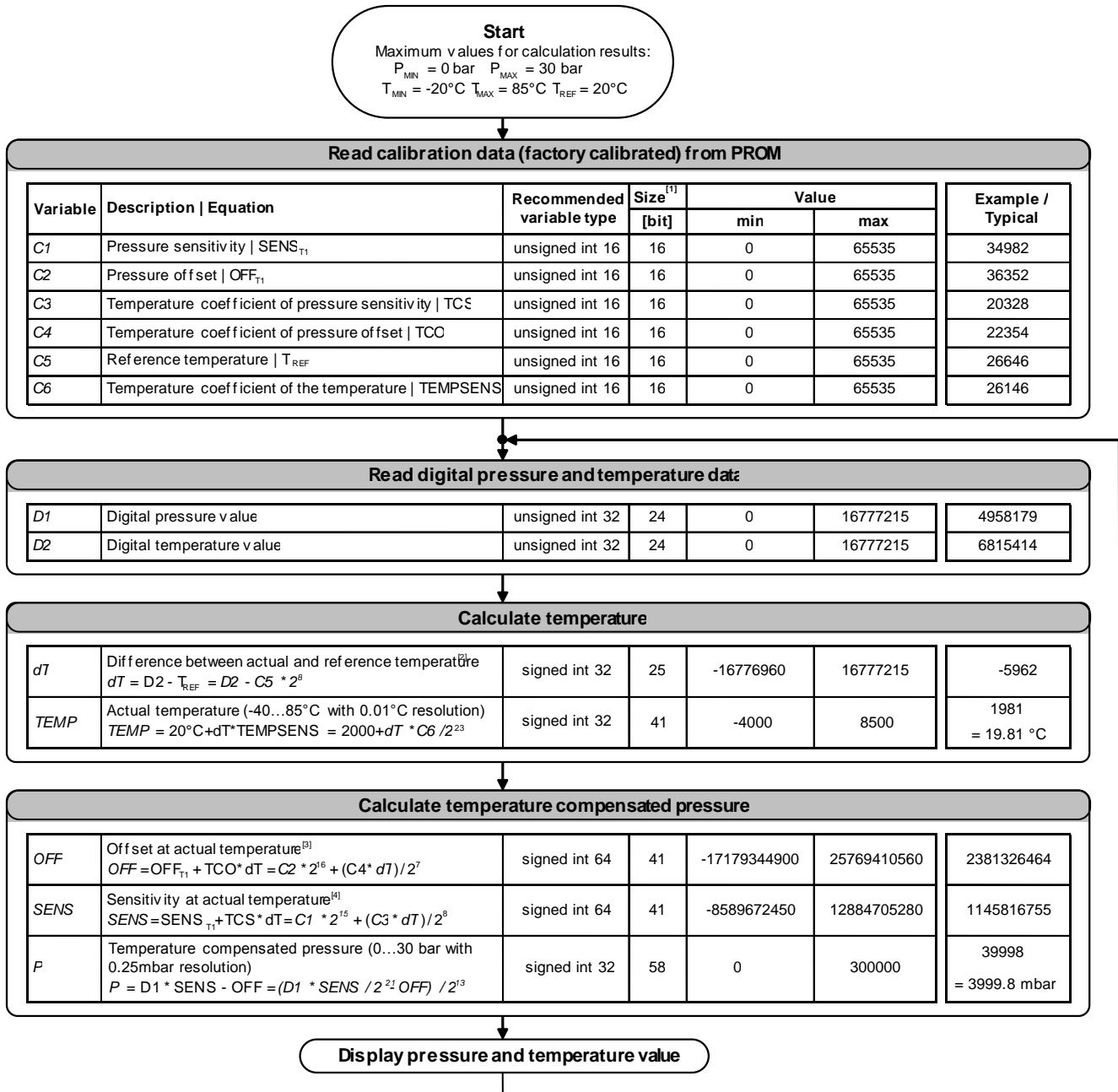

Notes

- [1] Maximal size of intermediate result during evaluation of variable
- [2] min and max have to be defined
- [3] min and max have to be defined
- [4] min and max have to be defined

Flow chart for pressure and temperature reading and software compensation.

SECOND ORDER TEMPERATURE COMPENSATION

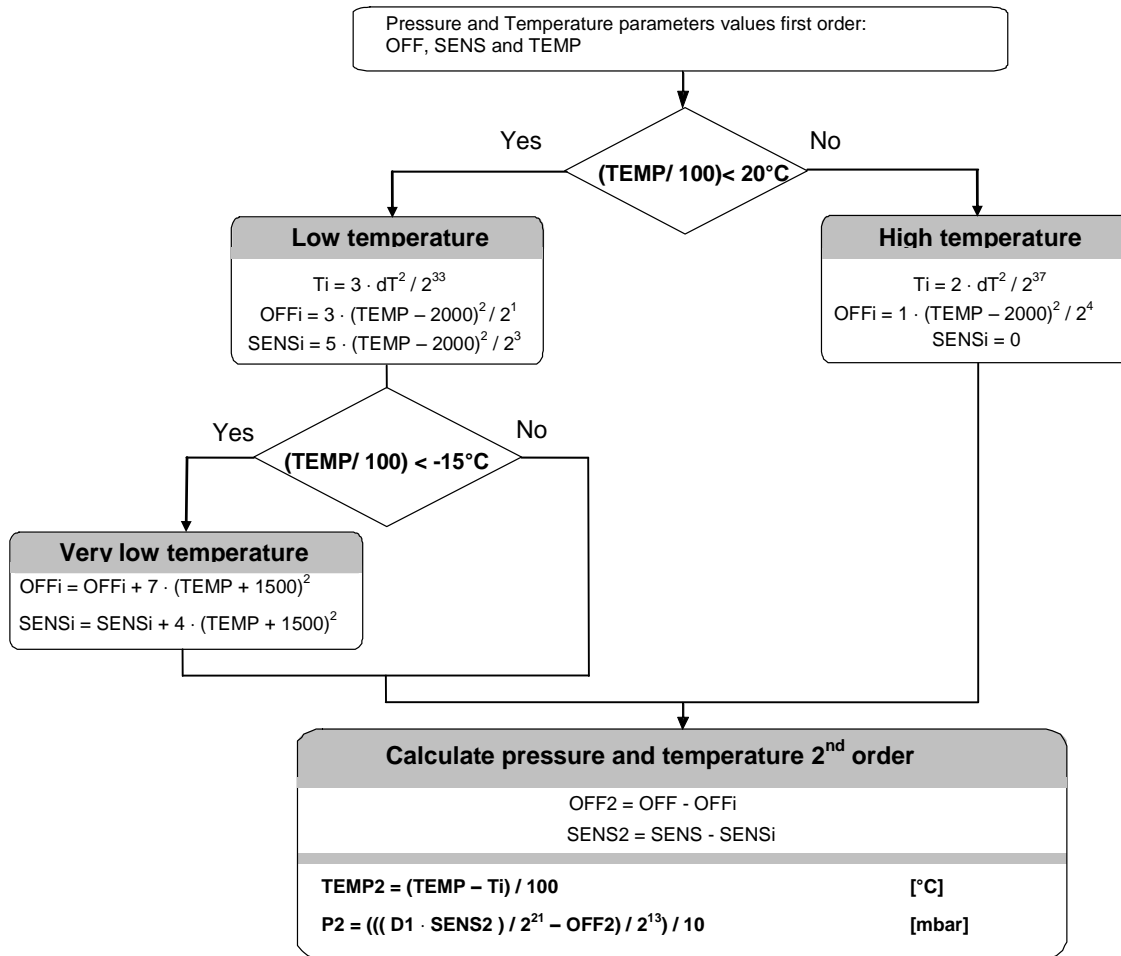

Flow chart for pressure and temperature to the optimum accuracy.



## I<sup>2</sup>C INTERFACE

### COMMANDS

The MS5837-30BA has only five basic commands:

1. Reset
2. Read PROM (112 bit of calibration words)
3. D1 conversion
4. D2 conversion
5. Read ADC result (24 bit pressure / temperature)

Each I<sup>2</sup>C communication message starts with the start condition and it is ended with the stop condition. The MS5837-30BA address is 1110110x (write: x=0, read: x=1).

Size of each command is 1 byte (8 bits) as described in the table below. After ADC read commands, the device will return 24 bit result and after the PROM read 16 bit results. The address of the PROM is embedded inside of the PROM read command using the a2, a1 and a0 bits.

Bit number	Command byte								hex value
	0	1	2	3	4	5	6	7	
Bit name	PRO M	CO NV	-	Typ	Ad2/ Os2	Ad1/ Os1	Ad0/ Os0	Stop	
Command									
Reset	0	0	0	1	1	1	1	0	0x1E
Convert D1 (OSR=256)	0	1	0	0	0	0	0	0	0x40
Convert D1 (OSR=512)	0	1	0	0	0	0	1	0	0x42
Convert D1 (OSR=1024)	0	1	0	0	0	1	0	0	0x44
Convert D1 (OSR=2048)	0	1	0	0	0	1	1	0	0x46
Convert D1 (OSR=4096)	0	1	0	0	1	0	0	0	0x48
Convert D1 (OSR=8192)	0	1	0	0	1	0	1	0	0x4A
Convert D2 (OSR=256)	0	1	0	1	0	0	0	0	0x50
Convert D2 (OSR=512)	0	1	0	1	0	0	1	0	0x52
Convert D2 (OSR=1024)	0	1	0	1	0	1	0	0	0x54
Convert D2 (OSR=2048)	0	1	0	1	0	1	1	0	0x56
Convert D2 (OSR=4096)	0	1	0	1	1	0	0	0	0x58
Convert D2 (OSR=8192)	0	1	0	1	1	0	1	0	0x5A
ADC Read	0	0	0	0	0	0	0	0	0x00
PROM Read	1	0	1	0	Ad2	Ad1	Ad0	0	0xA0 to 0xAE

Command structure

## RESET SEQUENCE

The Reset sequence shall be sent once after power-on to make sure that the calibration PROM gets loaded into the internal register. It can be also used to reset the device PROM from an unknown condition.

The reset can be sent at any time. In the event that there is not a successful power on reset this may be caused by the SDA being blocked by the module in the acknowledge state. The only way to get the MS5837-30BA to function is to send several SCLs followed by a reset sequence or to repeat power on reset.

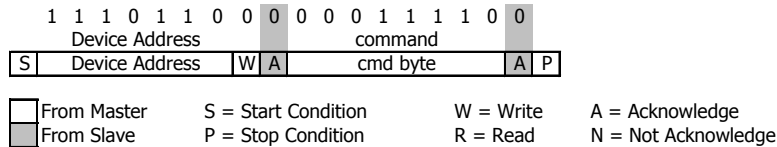

I<sup>2</sup>C Reset Command

## PROM READ SEQUENCE

The read command for PROM shall be executed once after reset by the user to read the content of the calibration PROM and to calculate the calibration coefficients. There are in total 7 addresses resulting in a total memory of 112 bit. Addresses contain factory data and the setup, calibration coefficients, the serial code and CRC. The command sequence is 8 bits long with a 16 bit result which is clocked with the MSB first. The PROM Read command consists of two parts. First command sets up the system into PROM read mode. The second part gets the data from the system.

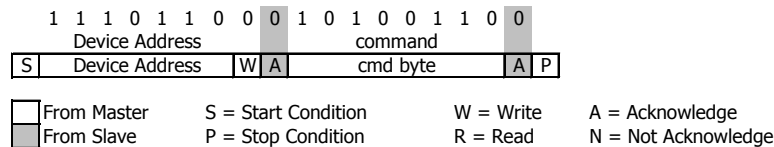

I<sup>2</sup>C Command to read memory address= 011

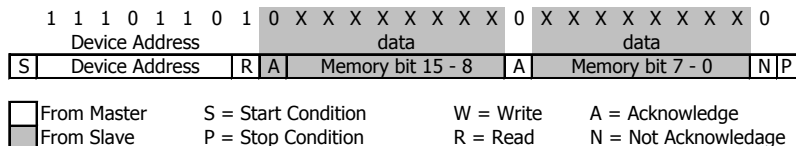

I<sup>2</sup>C answer from MS5837-30BA

### CONVERSION SEQUENCE

The conversion command is used to initiate uncompensated pressure (D1) or uncompensated temperature (D2) conversion. After the conversion, using ADC read command the result is clocked out with the MSB first. If the conversion is not executed before the ADC read command, or the ADC read command is repeated, it will give 0 as the output result. If the ADC read command is sent during conversion the result will be 0, the conversion will not stop and the final result will be wrong. Conversion sequence sent during the already started conversion process will yield incorrect result as well. A conversion can be started by sending the command to MS5837-30BA. When command is sent to the system it stays busy until conversion is done. When conversion is finished the data can be accessed by sending a Read command, when acknowledge is sent from the MS5837-30BA, 24 SCL cycles may be sent to receive all result bits. Every 8 bits the system waits for an acknowledge signal.

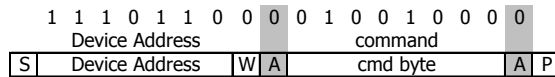

From Master      S = Start Condition      W = Write      A = Acknowledge  
 From Slave      P = Stop Condition      R = Read      N = Not Acknowledge

I<sup>2</sup>C command to initiate a pressure conversion (OSR=4096, typ=D1)

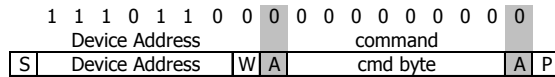

From Master      S = Start Condition      W = Write      A = Acknowledge  
 From Slave      P = Stop Condition      R = Read      N = Not Acknowledge

#### I<sup>2</sup>C ADC read sequence

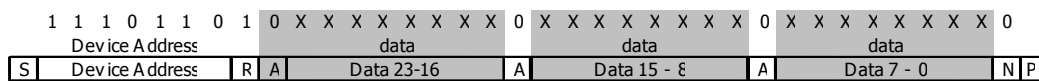

From Master      S = Start Condition      W = Write      A = Acknowledge  
 From Slave      P = Stop Condition      R = Read      N = Not Acknowledge

I<sup>2</sup>C answer from MS5837-30BA

## CYCLIC REDUNDANCY CHECK (CRC)

MS5837-30BA contains a PROM memory with 112-Bit. A 4-bit CRC has been implemented to check the data validity in memory. The besides C code describes in detail CRC-4 calculation.

C6	D B 1 5	D B 1 4	D B 1 3	D B 1 2	D B 1 1	D B 1 0	D B 9	D B 8	D B 7	D B 6	D B 5	D B 4	D B 3	D B 2	D B 1	D B 0
0	CRC		Factory defined													
1	C1															
2	C2															
3	C3															
4	C4															
5	C5															
6																

Memory PROM mapping

C Code example for CRC-4 calculation:

```

unsigned char crc4(unsigned int n_prom[])           // n_prom defined as 8x unsigned int (n_prom[8])
{
int cnt;                                           // simple counter
unsigned int n_rem=0;                             // crc remainder
unsigned char n_bit;

n_prom[0]=((n_prom[0]) & 0x0FFF);                // CRC byte is replaced by 0
n_prom[7]=0;                                     // Subsidiary value, set to 0
for (cnt=0; cnt < 16; cnt++)                     // operation is performed on bytes
{
if (cnt%2==1)    n_rem ^= (unsigned short) ((n_prom[cnt>>1]) & 0x00FF);
else            n_rem ^= (unsigned short) (n_prom[cnt>>1]>>8);
for (n_bit= 8; n_bit > 0; n_bit--)
{
if (n_rem & (0x8000))    n_rem = (n_rem << 1) ^ 0x3000;
else                    n_rem = (n_rem << 1);
}
}
n_rem= ((n_rem >> 12) & 0x000F);                 // final 4-bit remainder is CRC code
return (n_rem ^ 0x00);
}
    
```

## APPLICATION CIRCUIT

The MS5837 is a circuit that can be used in conjunction with a microcontroller in mobile altimeter applications.

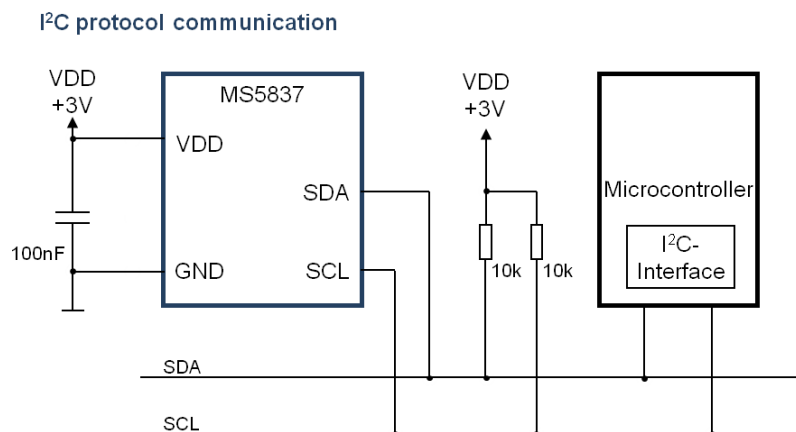

Typical application circuit

## PIN CONFIGURATION AND DEVICE PACKAGE OUTLINE

UNLESS OTHERWISE SPECIFIED DIMENSIONS ARE IN MILLIMETERS. GENERAL TOLERANCE  $\pm 0.1$

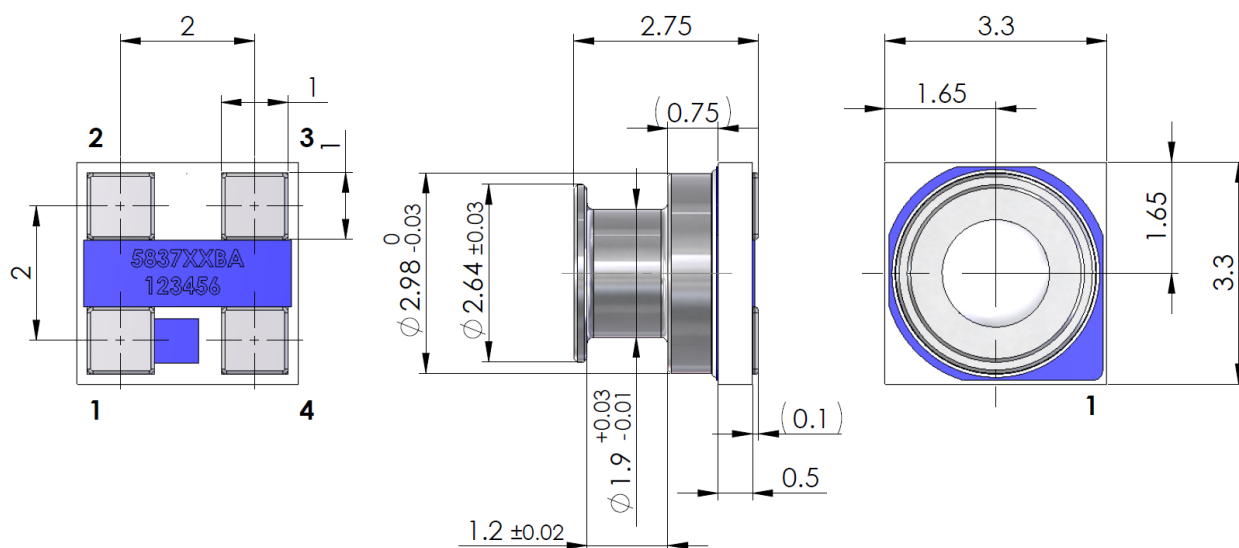

1	GND	GROUND
2	VDD	POSITIVE SUPPLY
3	SCL	I <sup>2</sup> C CLOCK
4	SDA	I <sup>2</sup> C DATA

Package outlines and Pin configuration

## RECOMMENDED PAD LAYOUT

Pad layout for bottom side of the MS5837-30BA soldered onto printed circuit board.

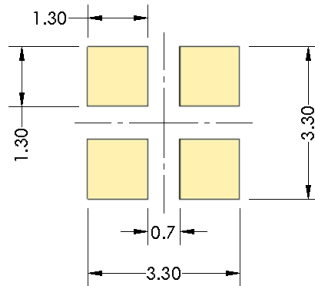

Recommended PCB footprint

## SHIPPING PACKAGE

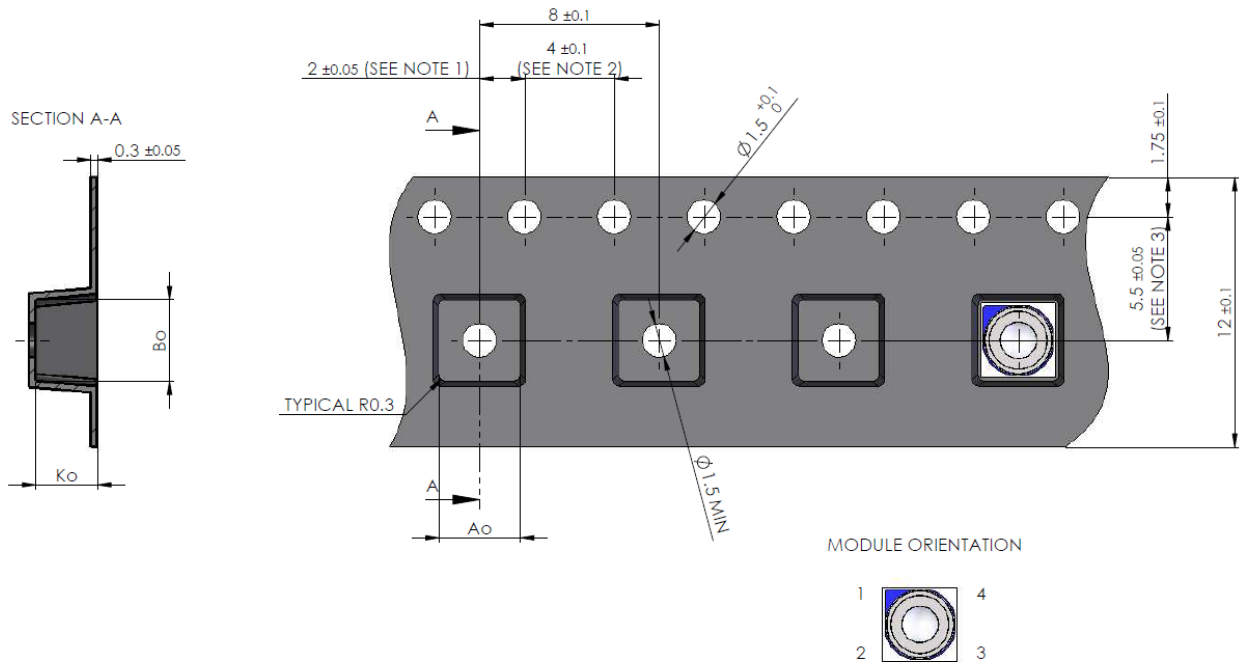

MODULE ORIENTATION



Ao	3.6±0.1
Bo	3.6±0.1
Ko	2.75±0.1

NOTE:

- 1: Measured from centerline of sprocket hole to centerline of pocket
- 2: Cumulative tolerance of 10 sprocket holes is ±0.2mm
- 3: Measured from centerline of sprocket hole to centerline of pocket

## MOUNTING AND ASSEMBLY CONSIDERATIONS

### SOLDERING

Please refer to the application note AN808 available on our website for all soldering recommendations.

### MOUNTING

The MS5837-30BA can be placed with automatic Pick & Place equipment using vacuum nozzles. It will not be damaged by the vacuum. Due to the low stress assembly the sensor does not show pressure hysteresis effects. It is important to solder all contact pads.

### CONNECTION TO PCB

The package outline of the module allows the use of a flexible PCB for interconnection. This can be important for applications in watches and other special devices.

### SEALING WITH O-RINGS

In applications such as outdoor watches the electronics must be protected against direct water or humidity. For such applications the MS5837-30BA provides the possibility to seal with an O-ring. The O-ring shall be placed at the groove location, i.e. the small outer diameter of the metal lid. The following O-ring / housing dimensions are recommended:

O-ring inner diameter	1.8 ± 0.05 mm
O-ring cross-section diameter	0.8 ± 0.03 mm
Housing bore diameter	3.07 ± 0.03 mm

Please refer to the application note AN523 available on our website for O-ring mounting recommendations.

### CLEANING

The MS5837-30BA has been manufactured under clean-room conditions. It is therefore recommended to assemble the sensor under class 10'000 or better conditions. Should this not be possible, it is recommended to protect the sensor opening during assembly from entering particles and dust. To avoid cleaning of the PCB, solder paste of type "no-clean" shall be used. Warning: cleaning might damage the sensor.

### ESD PRECAUTIONS

The electrical contact pads are protected against ESD up to 2 kV HBM (human body model). It is therefore essential to ground machines and personnel properly during assembly and handling of the device. The MS5837-30BA is shipped in antistatic transport boxes. Any test adapters or production transport boxes used during the assembly of the sensor shall be of an equivalent antistatic material.

### DECOUPLING CAPACITOR

Particular care must be taken when connecting the device to the power supply. A minimum of 100nF ceramic capacitor must be placed as close as possible to the MS5837-30BA VDD pin. This capacitor will stabilize the power supply during data conversion and thus, provide the highest possible accuracy.

ORDERING INFORMATION

Part Number / Art. Number	Product	Delivery Form
MS583730BA01-50	MS5837-30BA Ultra Small Gel Filled Pressure Sensor	Tape & Reel